

WALL MOUNT LOCKER

Designed for locker rooms with large built-in masonry risers, our Wall Mount Wood lockers have all the features of our full height lockers except for the seat and lower storage. They feature a coat rod that extend the full width of the locker (for players that prefer coat hangers) and 6 sturdy solid aluminum hooks for hanging garments.

Dimensions: 24" W x 21.5" D x 31" H

Also available in 30" Width

- ¾" Solid Maple door and front facings , all other parts are ¾" Maple veneer hardwood plywood.
- No particleboard, MDF, artificial wood laminate,PVC,or edgebanding.
- Upper storage compartment has built in MasterLock combination lock.
- 6 Solid aluminum hooks 2"
- 1 aluminum rod full width of locker.
- Ships fully assembled.
- Hidden dowel, glue, and screw construction.
- Material and workmanship guaranteed for 20 years.

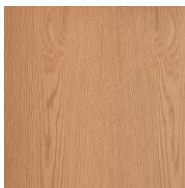

Autumn
Oak

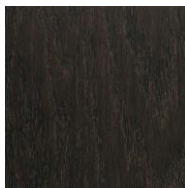

Charcoal
Oak



Driftwood
Oak

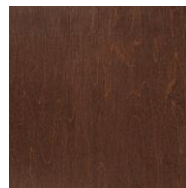

Espresso
Maple

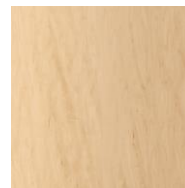

Hardrock
Maple

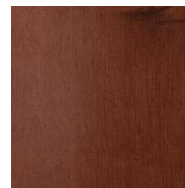

Rosewood
Maple

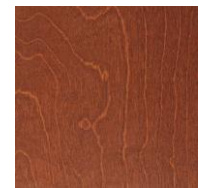

Cinnamon
Maple

Request a quote. Get FREE material/color samples. Get a FREE layout plan.

800-367-1133

ALLWOODLOCKERS.COM

WALL MOUNT LOCKER

24" WALL MOUNT

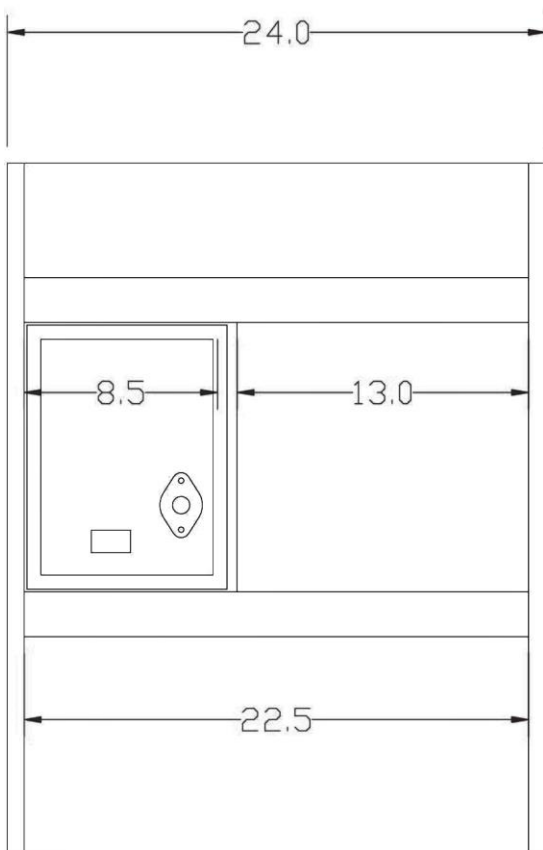

FRONT VIEW

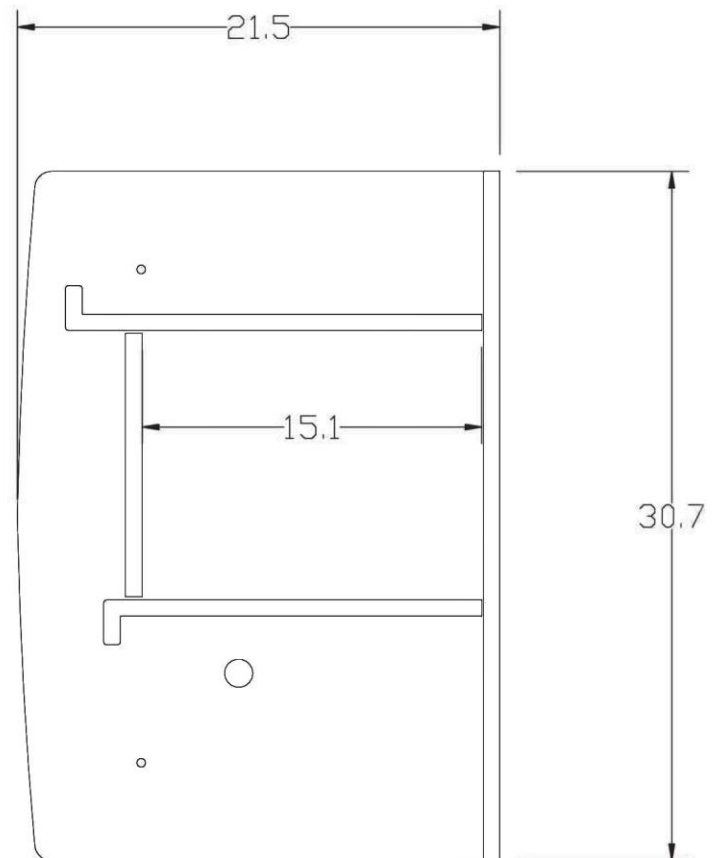

SIDE VIEW